

# SMTC1

Surface Mount Process Cleaner

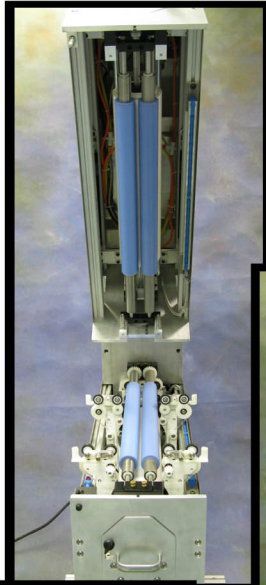

Clam-Shell opening  
for easy maintenance

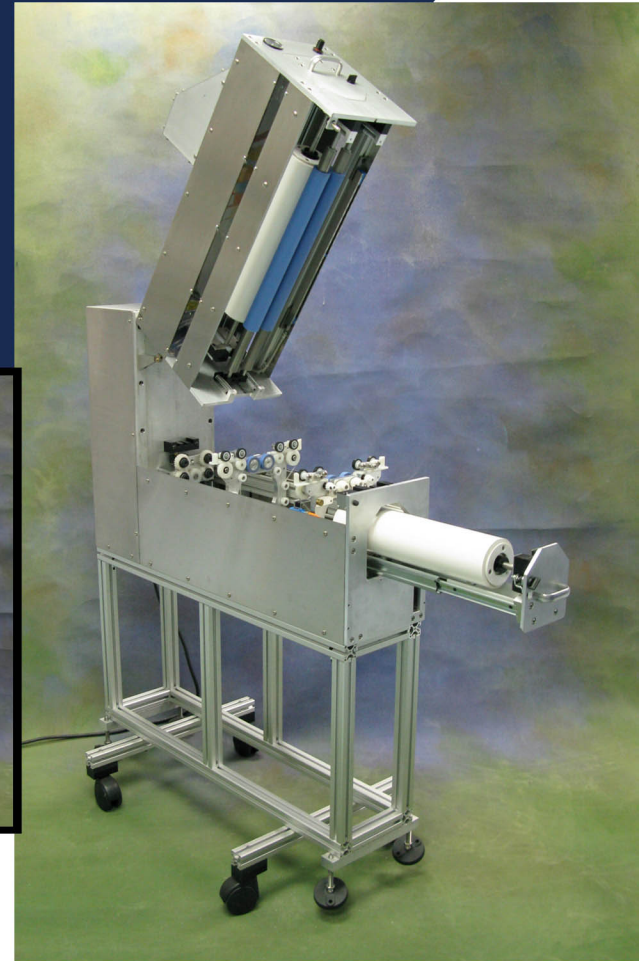
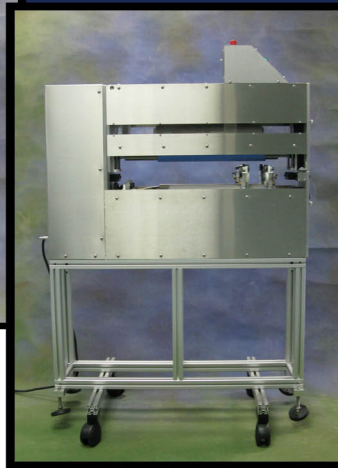

## CONTACT POLYMER ROLLER CLEANING MACHINE FOR SURFACE MOUNT/ASSEMBLY APPLICATIONS

The SMTC1 provides high efficiency cleaning without the use of any liquids, chemicals, or wipes. The SMTC1 eliminates contaminants (e.g. epoxy dust, loose solder mask, etc.) from the board surface. The unique edge transport system allows for smooth board travel. Simple touchscreen interface provides simple interface with adjustments for all machine operations and panel counter/alarm. The "SMART" anti-static system ensures that populated boards are not subjected to static charges.



# SMTC1

## Surface Mount Process Cleaner

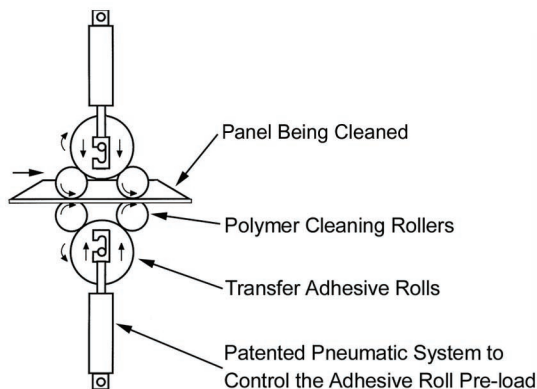
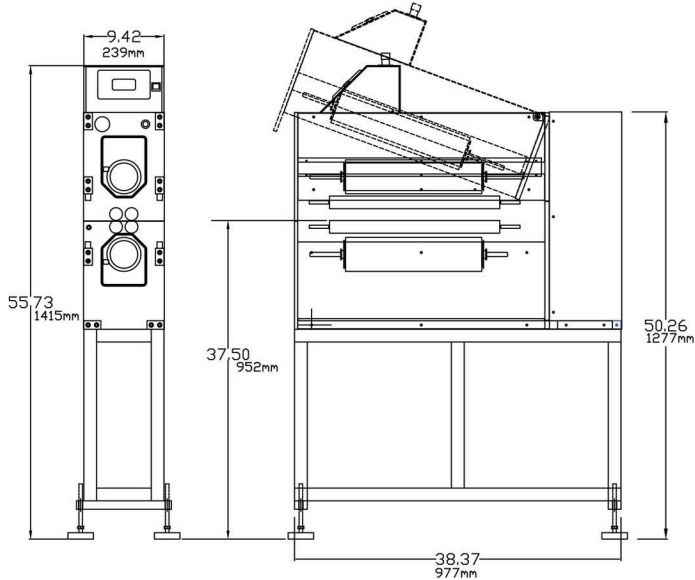
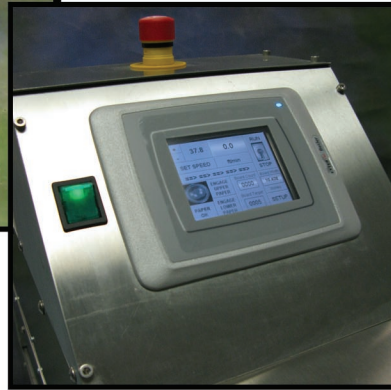
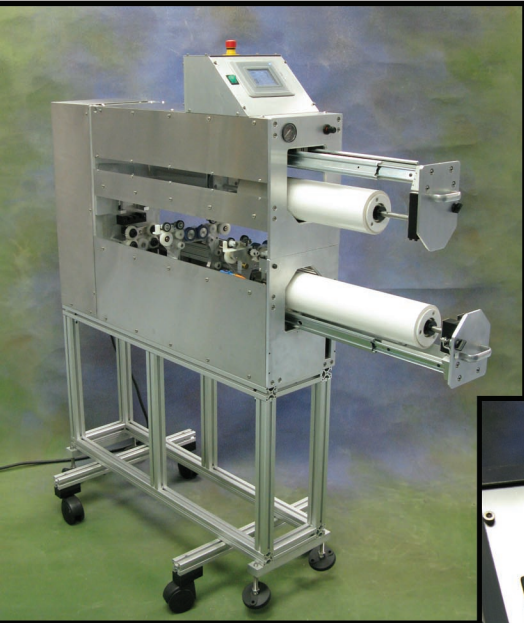

### THE CLEANING PROCESS

Special polymer rollers lift the contaminant from the panel and transfer it to the adhesive roll. When the adhesive roll becomes laden with contaminate, simply strip the outer layer exposing a new clean surface of adhesive.

### FEATURES

- Double Sided or Top-Side Cleaning
- Simple Touchscreen Interface
- Cleaning Width 1.5"-16" (4-400mm)
- Internal Edge Transport Entry & Exit
- Speed 0-100 FPM (30M/min)
- Minimum Board Length 2.95" (7.5mm)
- Stainless Steel Construction

### REQUIREMENTS

- 110 VAC or 220 VAC
- Air Supply (60 P.S.I./5 bar minimum)

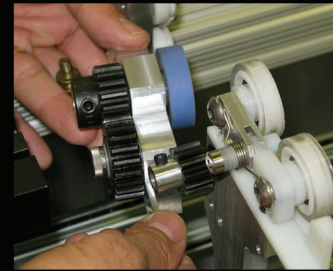

**Change Cleaning Modes in Seconds.  
No Tools Required!**

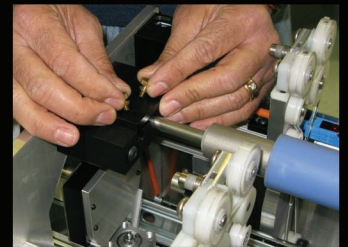

21 Morgan  
Irvine, CA 92618  
USA  
Tel: +1 (949) 583-1001  
Fax: +1 (949) 583-7007  
[www.sdionline.com](http://www.sdionline.com)

Established 1979 with over 1500 cleaning machines and over 100,000 manual systems sold worldwide.

Regional offices:  
USA - North Carolina  
Europe - UK & Poland  
Asia - Hong Kong & Taiwan